



LM592 Differential Video Amplifier

General Description

The LM592 is a two stage differential input, differential output, wideband video amplifier. The use of internal series-shunt feedback gives wide bandwidth with low phase distortion and high gain stability. Emitter follower outputs provide low output impedances necessary to drive capacitive loads. This device offers fixed gains of 100 and 400 with no external components plus the flexibility of adjusting the gain from 0 to 400 with the addition of a single resistor. This flexibility also allows the device to be configured as a high pass, low pass, or band pass filter.

The LM592 is ideal for use in magnetic memory systems. The device is also very useful as a video and pulse amplifier in video recorders and other communications systems.

Features

- 120 MHz bandwidth
- Adjustable gains from 0 to 400
- Adjustable pass band
- No frequency compensation required

Applications

- Disc file memories
- Magnetic tape systems
- Thin film or plated wire memories
- Wide band video amplifiers

Connection Diagram

Dual-In-Line and Small Outline Package

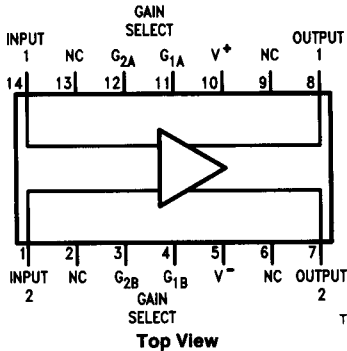

Order Number LM592M or LM592N
See NS Package Number M14A or N14A

Disc/Tape Phase Modulated Readback Systems

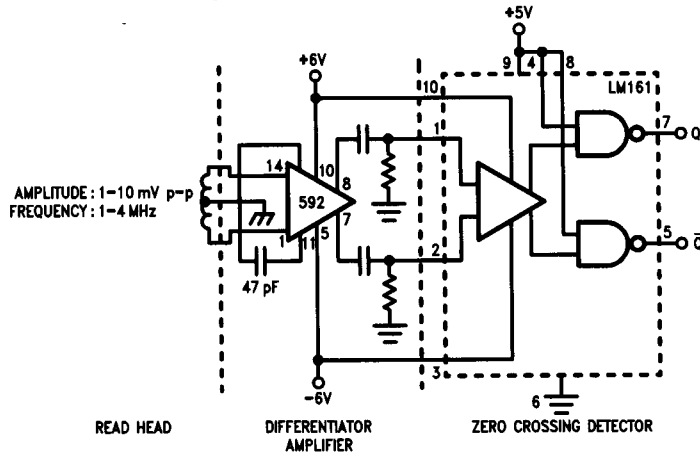

Absolute Maximum Ratings

If Military/Aerospace specified devices are required, please contact the National Semiconductor Sales Office/Distributors for availability and specifications.

Differential Input Voltage	±5V
Common Mode Input Voltage	±6V
V _{supply}	±8V
Output Current	10 mA
Power Dissipation (Note 1)	500 mW
Junction Temperature	+150°C
Storage Temperature Range	-65°C to +150°C

Operating Temperature Range	0°C to +70°C
Soldering Information	
Dual-In-Line Package	
Soldering (10 seconds)	260°C
Small Outline Package	
Vapor Phase (60 seconds)	215°C
Infrared (15 seconds)	220°C
See AN-450 "Surface Mounting Methods and Their Effect on Product Reliability" for other methods of soldering surface mount devices.	

Electrical Characteristics T_A = 25°C, unless otherwise specified, see test circuits, V_S = ±6.0V (Note 5)

Characteristics	Test Circuit	Test Conditions	LM592			Units (Limit)
			Typ	Tested Limit (Note 6)	Design Limit (Note 7)	
Differential Voltage Gain Gain 1 (Note 2)	1	R _L = 2 kΩ, V _{OUT} = 3 V _{PP}	400	250	210	(Min)
Gain 2 (Note 3)			100	600	620	(Max)
Bandwidth	2		40			MHz
Gain 1			90			MHz
Rise Time	2	V _{OUT} = 1 V _{PP}	10.5		12	ns
Gain 1			4.5			ns (Max)
Propagation Delay	2	V _{OUT} = 1 V _{PP}	7.5		10	ns
Gain 1			6			ns (Max)
Input Resistance		Gain 2	4		10	kΩ
Gain 1			23			kΩ (Min)
Input Capacitance			2			pF
Input Offset Current			0.4	5	6	μA (Max)
Input Bias Current			9	26	31	μA (Max)
Input Noise Voltage		BW = 1 kHz to 10 MHz	12			μV rms
Input Voltage Range	1			±1	±1	V (Min)
Common Mode Rejection Ratio	1	V _{CM} = ±1V V _{CM} = ±1V, f = 5 mHz	86	60	50	dB (Min)
Gain 2			60			dB
Supply Voltage Rejection Ratio	1	ΔV _S = ±0.5V	70	50	50	dB (Min)
Output Offset Voltage	1	R _L = ∞	0.35	0.75	0.75	V (Max)
Output Common Mode Voltage	1	R _L = ∞	2.9	2.4	2.4	V (Min)
(Note 4)			3.4	3.4	V (Max)	
Output Voltage Swing	1	R _L = 2k	4	3	3	V (Min)
Output Sink Current			3.6	2.5	2.3	mA (Min)
Output Resistance			20			Ω
Power Supply Current	1	R _L = ∞	18	24	24	mA (Max)

Note 1: For operation at elevated temperatures, these devices must be derated based on a thermal resistance of θ_{JA} and T_{Jmax}. θ_{JA} = 90°C/W in the "N" package and 135°C/W in the "M" package. T_{Jmax} = 150°C.

Note 2: Pins G1A and G1B connected together.

Note 3: Pins G2A and G2B connected together.

Note 4: Gain select pins open. Output Common Mode Voltage = (V_{O1} + V_{O2})/2.

Note 5: Boldface numbers apply at temperature extremes.

Note 6: Guaranteed and 100% production tested.

Note 7: Guaranteed (but not 100% production tested) over the operating temperature and supply voltage ranges. These limits are not used to calculate outgoing quality levels.

Typical Applications

Filter Networks

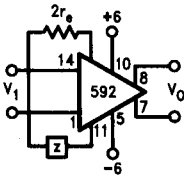

TL/H/6701-3

$$\begin{aligned} \frac{V_O(s)}{V_I(s)} &= \frac{1.4 \times 10^4}{Z(s) + 2r_e} \\ &= \frac{1.4 \times 10^4}{Z(s) + 32} \end{aligned}$$

BASIC CONFIGURATION

Impedance Network	Desired Filter	$\frac{V_O(s)}{V_I(s)}$ Transfer Function
 TL/H/6701-10	Low Pass	$\frac{1.4 \times 10^4}{L} \left[\frac{1}{s + R/L} \right]$
 TL/H/6701-11	High Pass	$\frac{1.4 \times 10^4}{R} \left[\frac{1}{s + 1/RC} \right]$
 TL/H/6701-12	Band Pass	$\frac{1.4 \times 10^4}{L} \left[\frac{s}{s^2 + R/Ls + 1/LC} \right]$
 TL/H/6701-13	Band Reject	$\frac{1.4 \times 10^4}{R} \left[\frac{s^2 + 1/LC}{s^2 + 1/LC + s/RC} \right]$

Note: In the networks above, the R value used is assumed to include $2r_e$, or approximately 32Ω

Test Circuits

Test Circuit 1

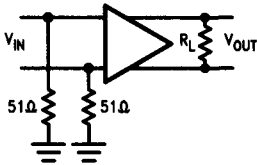

TL/H/6701-4

Test Circuit 2

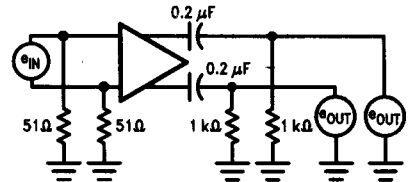

TL/H/6701-5

Voltage Gain Adjust Circuit

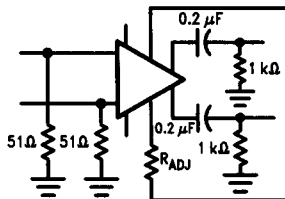

TL/H/6701-6

$V_S = \pm 6V$
 $T_A = 25^\circ C$

Schematic Diagram

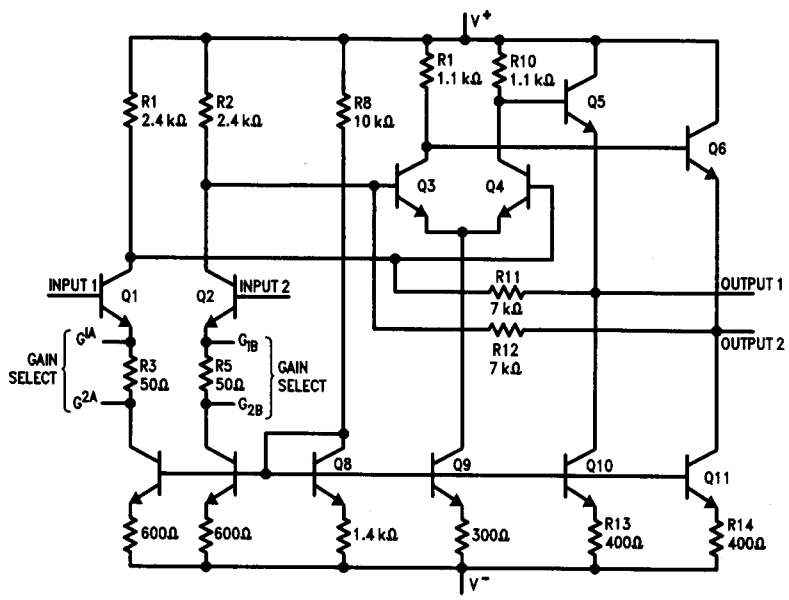

TL/H/6701-7

Typical Performance Characteristics

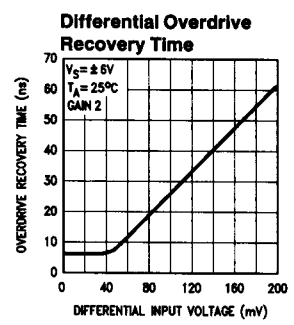
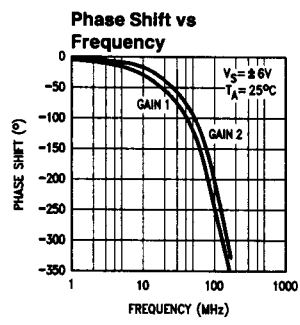
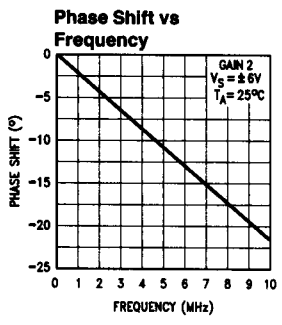
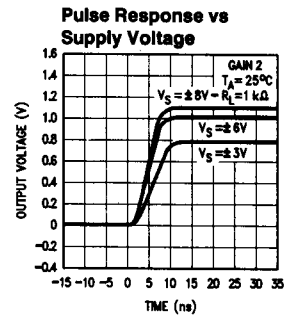
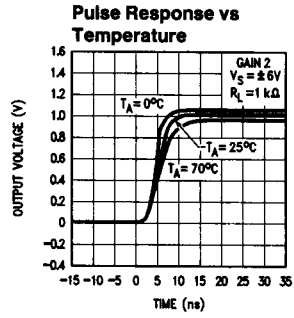
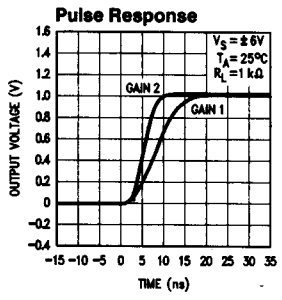

TL/H/6701-8

Typical Performance Characteristics (Continued)

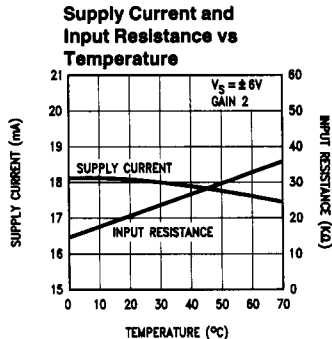
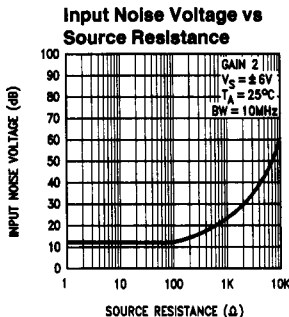
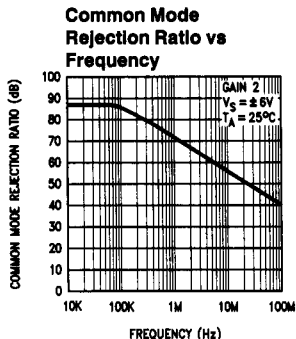
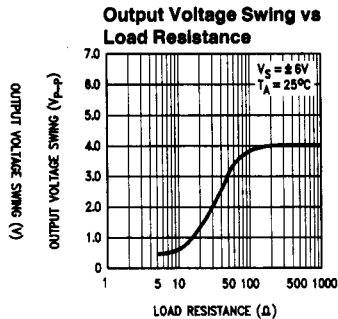
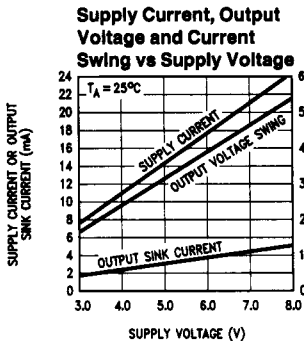
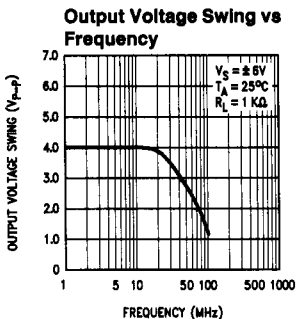
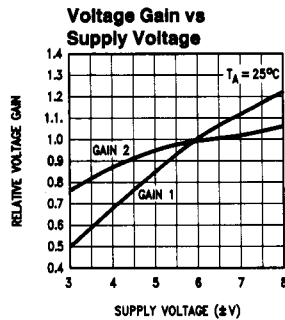
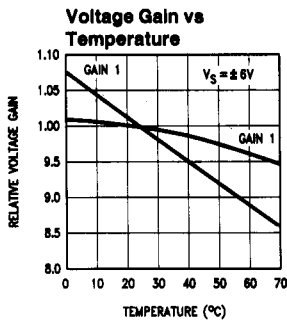
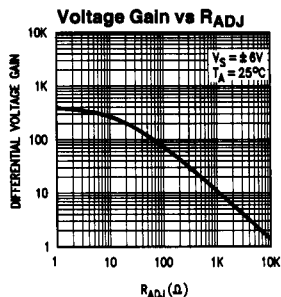
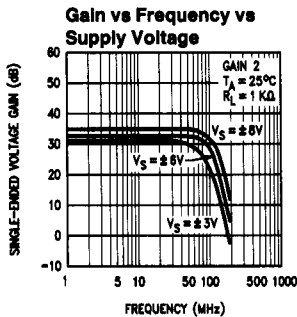
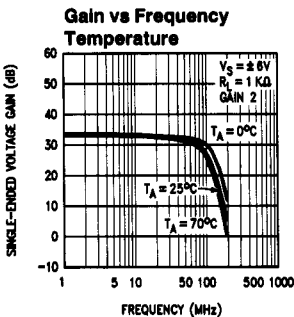
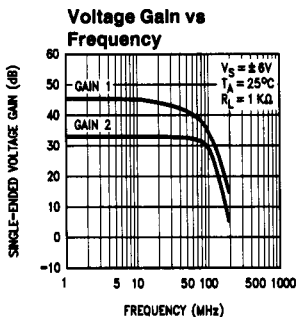

TL/H/8701-9

This datasheet has been downloaded from:

www.DatasheetCatalog.com

Datasheets for electronic components.