

DS26C32AT/DS26C32AM

Quad Differential Line Receiver

General Description

The DS26C32A is a quad differential line receiver designed to meet the RS-422, RS-423, and Federal Standards 1020 and 1030 for balanced and unbalanced digital data transmission, while retaining the low power characteristics of CMOS.

The DS26C32A has an input sensitivity of 200 mV over the common mode input voltage range of $\pm 7V$. The DS26C32A features internal pull-up and pull-down resistors which prevent output oscillation on unused channels.

The DS26C32A provides an enable and disable function common to all four receivers, and features TRI-STATE[®] outputs with 6 mA source and sink capability. This product is pin compatible with the DS26LS32A and the AM26LS32.

Features

- CMOS design for low power
- $\pm 0.2V$ sensitivity over input common mode voltage range
- Typical propagation delays: 19 ns
- Typical input hysteresis: 60 mV
- Inputs won't load line when $V_{CC} = 0V$
- Meets the requirements of EIA standard RS-422
- TRI-STATE outputs for connection to system buses
- Available in Surface Mount
- Mil-Std-883C compliant

Logic Diagram

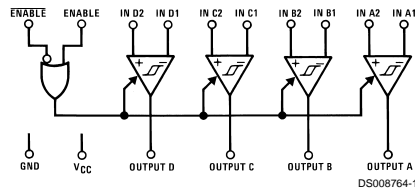

Connection Diagrams

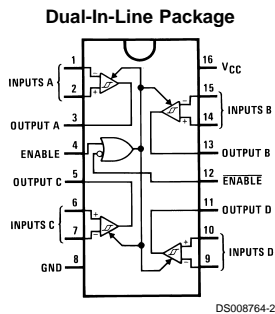

Top View

Order Number DS26C32ATM or DS26C32ATN
See NS Package M16A or N16E

For Complete Military Product Specifications,
refer to the appropriate SMD or MDS.

Order Number DS26C32AME/883, DS26C32AMJ/883 or
DS26C32AMW/883

See NS Package E20A, J16A or W16A

20-Lead Ceramic Leadless Chip Carrier

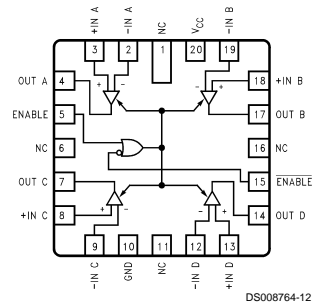

Absolute Maximum Ratings (Notes 2, 1)

If Military/Aerospace specified devices are required, please contact the National Semiconductor Sales Office/Distributors for availability and specifications.

Supply Voltage (V_{CC})	7V
Common Mode Range (V_{CM})	$\pm 14V$
Differential Input Voltage (V_{DIFF})	$\pm 14V$
Enable Input Voltage (V_{IN})	7V
Storage Temperature Range (T_{STG})	$-65^{\circ}C$ to $+150^{\circ}C$
Lead Temperature (Soldering 4 sec.)	$260^{\circ}C$
Maximum Power Dissipation at $25^{\circ}C$ (Note 5)	
Ceramic "J" Pkg.	2308 mW
Plastic "N" Pkg.	1645 mW
SOIC "M" Pkg.	1190 mW

Ceramic "E" Pkg.	2108 mW
Ceramic "W" Pkg.	1215 mW
Maximum Current Per Output	± 25 mA
This device does not meet 2000V ESD rating. (Note 4)	

Operating Conditions

	Min	Max	Units
Supply Voltage (V_{CC})	4.50	5.50	V
Operating Temperature Range (T_A)			
DS26C32AT	-40	+85	$^{\circ}C$
DS26C32AM	-55	+125	$^{\circ}C$
Enable Input Rise or Fall Times		500	ns

DC Electrical Characteristics

$V_{CC} = 5V \pm 10\%$ (unless otherwise specified) (Note 1)

Symbol	Parameter	Conditions	Min	Typ	Max	Units
V_{TH}	Minimum Differential Input Voltage	$V_{OUT} = V_{OH}$ or V_{OL} $-7V < V_{CM} < +7V$	-200	35	+200	mV
R_{IN}	Input Resistance	$V_{IN} = -7V, +7V$ (Other Input = GND)				
		DS26C32AT	5.0	6.8	10	k Ω
		DS26C32AM	4.5	6.8	11	k Ω
I_{IN}	Input Current	$V_{IN} = +10V$, Other Input = GND				
		DS26C32AT		+1.1	+1.5	mA
		DS26C32AM		+1.1	+1.8	mA
		$V_{IN} = -10V$, Other Input = GND				
		DS26C32AT		-2.0	-2.5	mA
		DS26C32AM		-2.0	-2.7	mA
V_{OH}	Minimum High Level Output Voltage	$V_{CC} = \text{Min}$, $V_{DIFF} = +1V$ $I_{OUT} = -6.0$ mA	3.8	4.2		V
V_{OL}	Maximum Low Level Output Voltage	$V_{CC} = \text{Max}$, $V_{DIFF} = -1V$ $I_{OUT} = 6.0$ mA		0.2	0.3	V
V_{IH}	Minimum Enable High Input Level Voltage		2.0			V
V_{IL}	Maximum Enable Low Input Level Voltage				0.8	V
I_{OZ}	Maximum TRI-STATE [®] Output Leakage Current	$V_{OUT} = V_{CC}$ or GND, ENABLE = V_{IL} , ENABLE = V_{IH}		± 0.5	± 5.0	μA
I_I	Maximum Enable Input Current	$V_{IN} = V_{CC}$ or GND			± 1.0	μA
I_{CC}	Quiescent Power Supply Current	$V_{CC} = \text{Max}$, $V_{DIF} = +1V$				
		DS26C32AT		16	23	mA
		DS26C32AM		16	25	mA
V_{HYST}	Input Hysteresis	$V_{CM} = 0V$		60		mV

AC Electrical Characteristics

$V_{CC} = 5V \pm 10\%$ (Note 3)

Symbol	Parameter	Conditions	Min	Typ	Max		Units
					DS26C32AT	DS26C32AM	
t_{PLH} , t_{PHL}	Propagation Delay Input to Output	$C_L = 50$ pF $V_{DIFF} = 2.5V$ $V_{CM} = 0V$	10	19	30	35	ns

AC Electrical Characteristics (Continued)

$V_{CC} = 5V \pm 10\%$ (Note 3)

Symbol	Parameter	Conditions	Min	Typ	Max		Units
					DS26C32AT	DS26C32AM	
t_{RISE} , t_{FALL}	Output Rise and Fall Times	$C_L = 50 \text{ pF}$ $V_{DIFF} = 2.5V$ $V_{CM} = 0V$		4	9	9	ns
t_{PLZ} , t_{PHZ}	Propagation Delay ENABLE to Output	$C_L = 50 \text{ pF}$ $R_L = 1000\Omega$ $V_{DIFF} = 2.5V$		13	22	29	ns
t_{PZL} , t_{PZH}	Propagation Delay ENABLE to Output	$C_L = 50 \text{ pF}$ $R_L = 1000\Omega$ $V_{DIFF} = 2.5V$		13	23	29	ns

Note 1: Absolute Maximum Ratings are those values beyond which the safety of the device cannot be guaranteed. They are not meant to imply that the device should be operated at these limits. The table of "Electrical Characteristics" provides conditions for actual device operation.

Note 2: Unless otherwise specified, all voltages are referenced to ground.

Note 3: Unless otherwise specified, Min/Max limits apply over recommended operating conditions. All typicals are given for $V_{CC} = 5V$ and $T_A = 25^\circ\text{C}$.

Note 4: ESD Rating: HBM (1.5 k Ω , 100 pF)

Inputs $\geq 2000V$

All other pins $\geq 1000V$

EIAJ (0 Ω , 200 pF) $\geq 350V$

Note 5: Ratings apply to ambient temperature at 25°C . Above this temperature derate N Package 13.16 mW/ $^\circ\text{C}$, J Package 15.38 mW/ $^\circ\text{C}$, M Package 9.52 mW/ $^\circ\text{C}$, E Package 12.04 mW/ $^\circ\text{C}$, and W package 6.94 mW/ $^\circ\text{C}$.

Comparison Table of Switching Characteristics into "LS-Type" Load

(Figures 4, 5, 6) (Note 6)

Symbol	Parameter	Conditions	DS26C32A	DS26LS32A	Units
			Typ	Typ	
t_{PLH}	Input to Output	$C_L = 15 \text{ pF}$	17	23	ns
t_{PHL}	Input to Output	$C_L = 15 \text{ pF}$	19	23	ns
t_{LZ}	ENABLE to Output	$C_L = 5 \text{ pF}$	13	15	ns
t_{HZ}	ENABLE to Output	$C_L = 5 \text{ pF}$	12	20	ns
t_{ZL}	ENABLE to Output	$C_L = 15 \text{ pF}$	13	14	ns
t_{ZH}	ENABLE to Output	$C_L = 15 \text{ pF}$	13	15	ns

Note 6: This table is provided for comparison purposes only. The values in this table for the DS26C32A reflect the performance of the device, but are not tested or guaranteed.

Test and Switching Waveforms

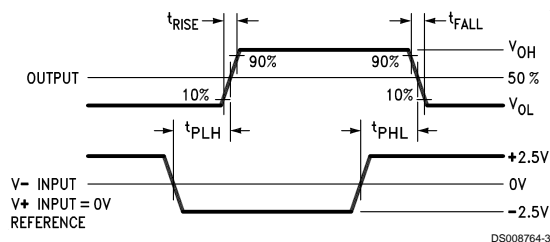
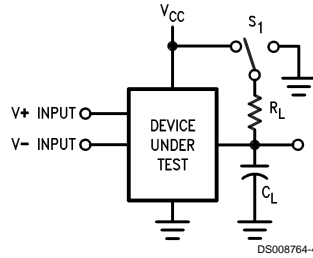

FIGURE 1. Propagation Delay

Test and Switching Waveforms (Continued)



C_L includes load and test jig capacitance.
 $S_1 = V_{CC}$ for t_{PZL} and t_{PLZ} measurements.
 $S_1 = \text{Gnd}$ for t_{PZH} and t_{PHZ} measurements.

FIGURE 2. Test Circuit for TRI-STATE Output Tests

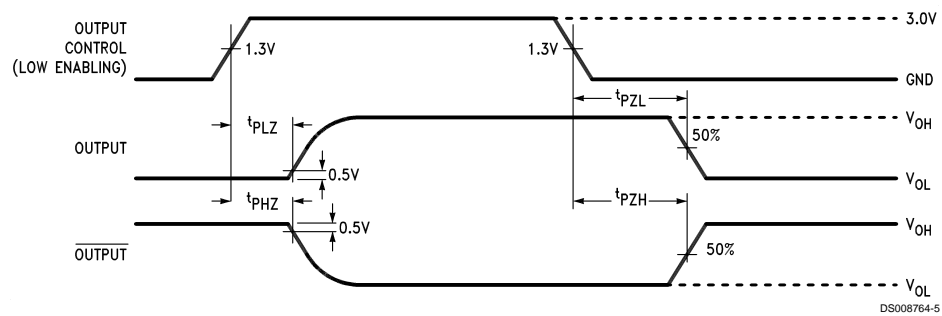

FIGURE 3. TRI-STATE® Output Enable and Disable Waveforms

AC Test Circuit and Switching Time Waveforms

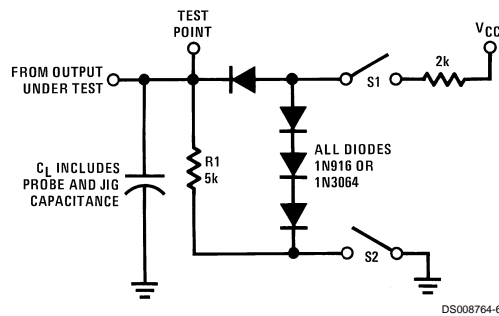

FIGURE 4. Load Test Circuit for TRI-STATE Outputs for "LS-Type" Load

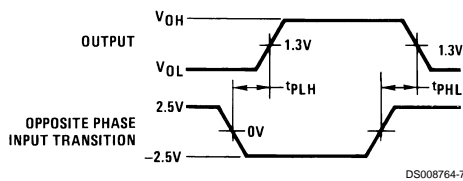

FIGURE 5. Propagation Delay for "LS-Type" Load (Notes 7, 9)

AC Test Circuit and Switching Time Waveforms (Continued)

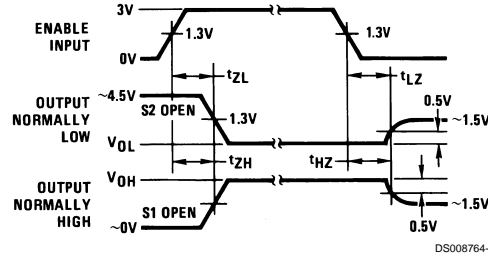

FIGURE 6. Enable and Disable Times for “LS-Type” Load (Notes 8, 9)

Note 7: Diagram shown for $\overline{\text{ENABLE}}$ low.

Note 8: S1 and S2 of load circuit are closed except where shown.

Note 9: Pulse generator for all pulses: Rate ≤ 1.0 MHz; $Z_0 = 50\Omega$; $t_r \leq 15$ ns; $t_f \leq 6.0$ ns.

Truth Table

ENABLE	$\overline{\text{ENABLE}}$	Input	Output
L	H	X	Z
All Other Combinations of Enable Inputs		$V_{ID} \geq V_{TH}$ (Max)	H
		$V_{ID} \leq V_{TH}$ (Min)	L
		Open	H

Z = TRI-STATE

Typical Applications

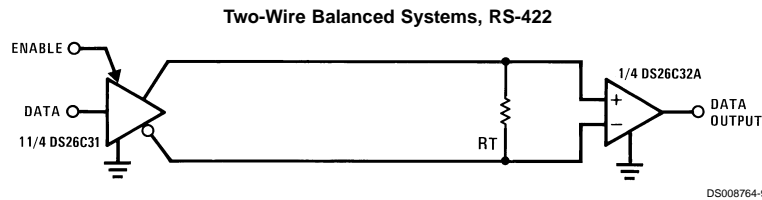

Typical Performance Characteristics

Differential Propagation Delay vs Temperature

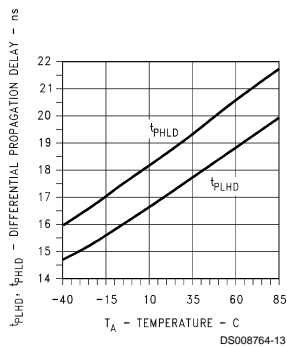

Differential Propagation Delay vs Power Supply Voltage

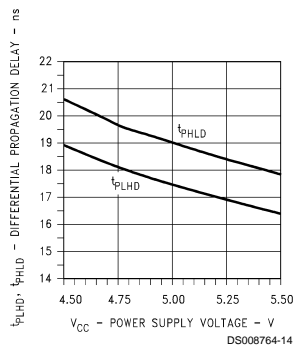

Differential Skew vs Temperature

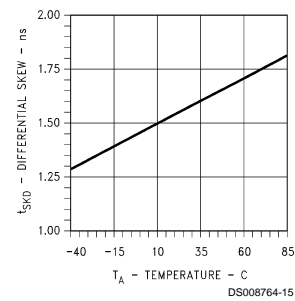

Typical Performance Characteristics (Continued)

Differential Skew vs Power Supply Voltage

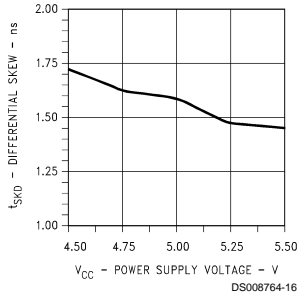

Output High Voltage vs Output High Current

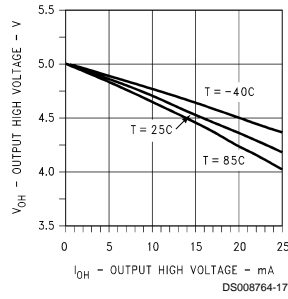

Output High Voltage vs Output High Current

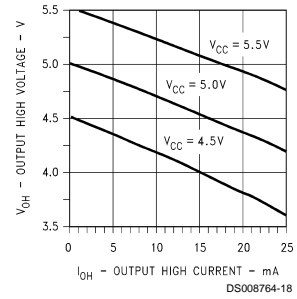

Output Low Voltage vs Output Low Current

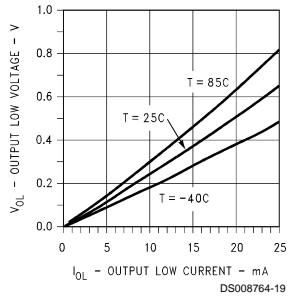

Output Low Voltage vs Output Low Current

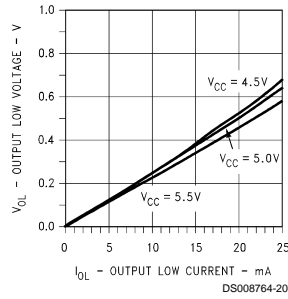

Input Resistance vs Input Voltage

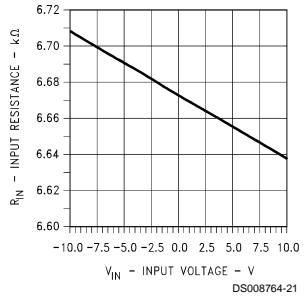

Input Current vs Power Supply Voltage

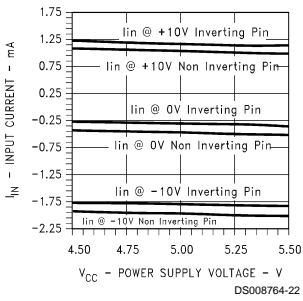

Hysteresis & Differential Transition Voltage vs Temperature

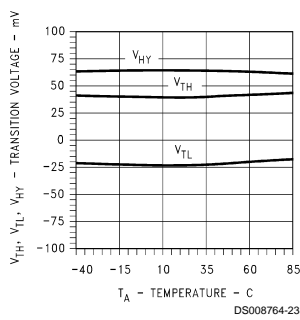

Hysteresis & Differential Transition Voltage vs Power Supply Voltage

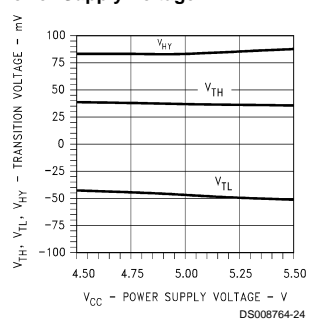

Typical Performance Characteristics (Continued)

Supply Current vs Temperature

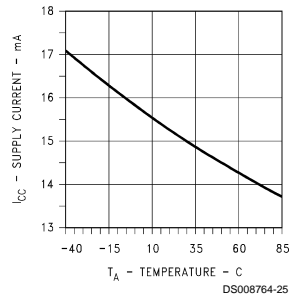

Disabled Supply Current vs Power Supply Voltage

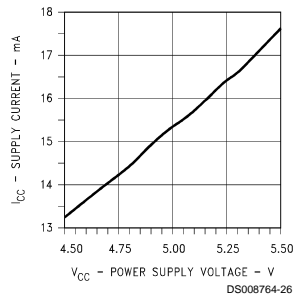

Supply Current vs Data Rate

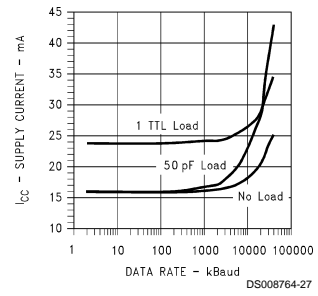

Physical Dimensions inches (millimeters) unless otherwise noted

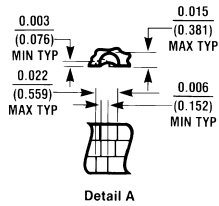
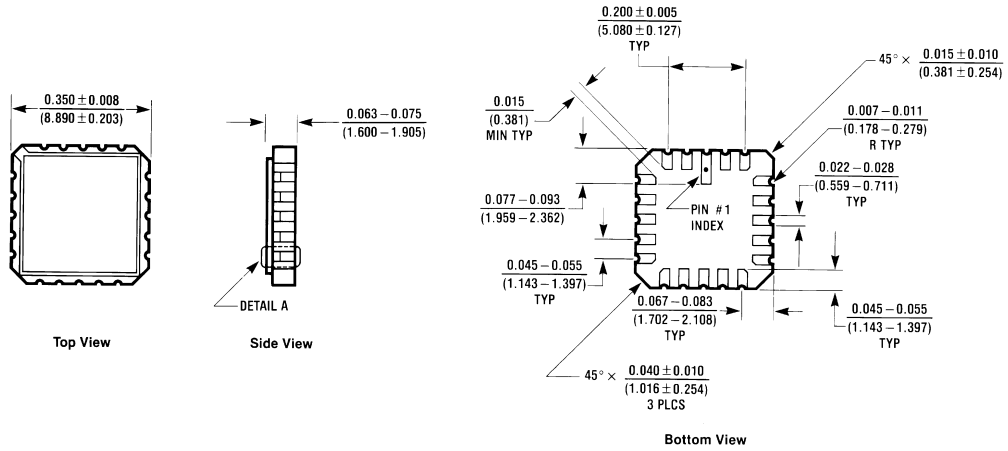

20-Lead Ceramic Leadless Chip Carrier (E)
Order Number DS26C32AME/883
NS Package Number E20A

E20A (REV D)

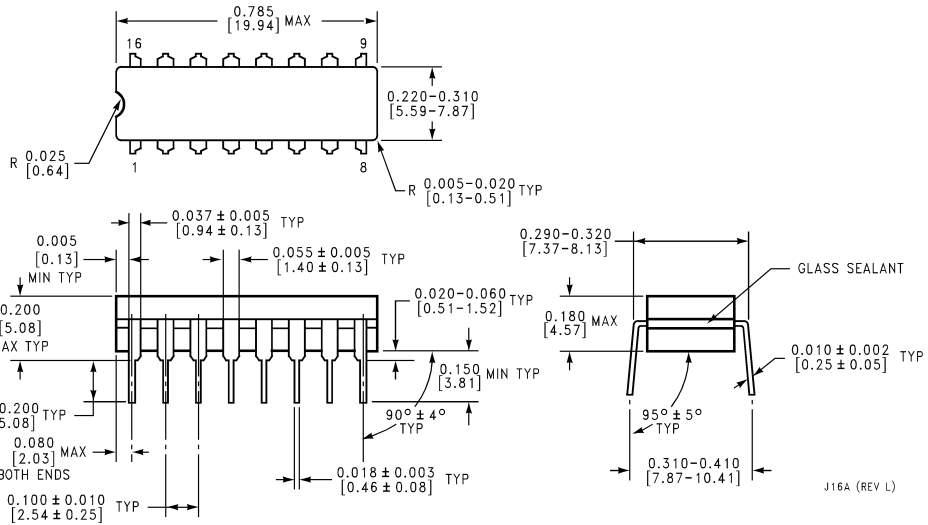

16-Lead Ceramic Dual-In-Line Package (J)
Order Number DS26C32AMJ/883
NS Package Number J16A

J16A (REV L)

Physical Dimensions inches (millimeters) unless otherwise noted (Continued)

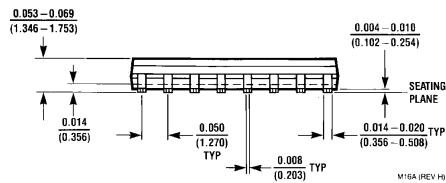
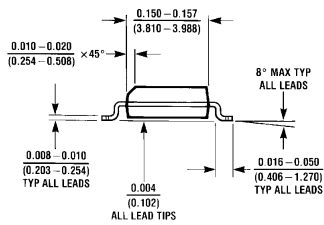
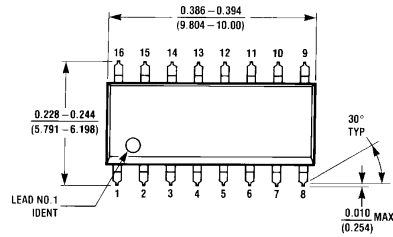

16-Lead Molded Small Outline Package (M)
Order Number DS26C32ATM
NS Package Number M16A

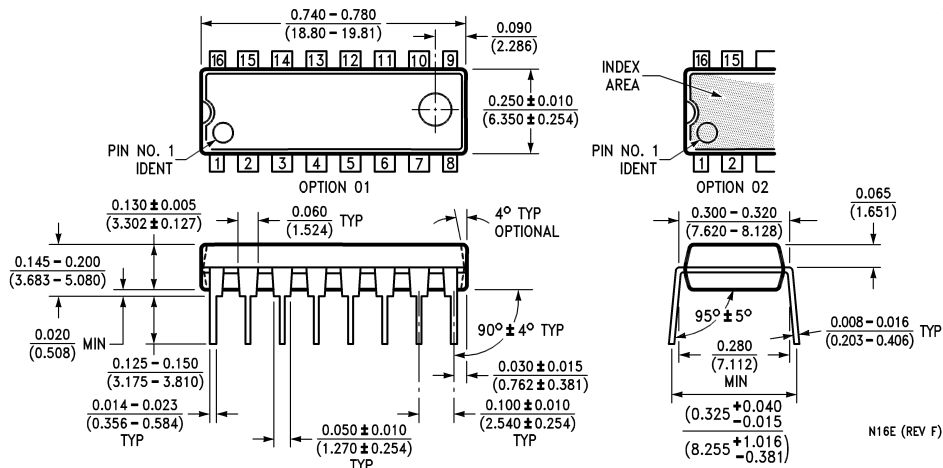

16-Lead Molded Dual-In-Line Package (N)
Order Number DS26C32ATN
NS Package Number N16E

DS26C32AT/DS26C32AM Quad Differential Line Receiver

Physical Dimensions inches (millimeters) unless otherwise noted (Continued)

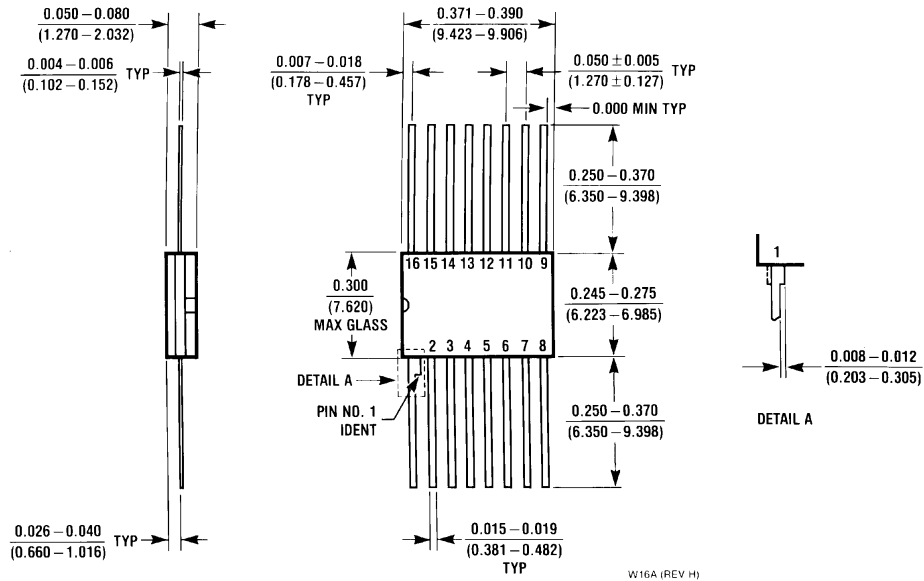

16-Lead Ceramic FlatPak (W)
Order Number DS26C32AMW/883
NS Package Number W16A

LIFE SUPPORT POLICY

NATIONAL'S PRODUCTS ARE NOT AUTHORIZED FOR USE AS CRITICAL COMPONENTS IN LIFE SUPPORT DEVICES OR SYSTEMS WITHOUT THE EXPRESS WRITTEN APPROVAL OF THE PRESIDENT OF NATIONAL SEMICONDUCTOR CORPORATION. As used herein:

1. Life support devices or systems are devices or systems which, (a) are intended for surgical implant into the body, or (b) support or sustain life, and whose failure to perform when properly used in accordance with instructions for use provided in the labeling, can be reasonably expected to result in a significant injury to the user.
2. A critical component in any component of a life support device or system whose failure to perform can be reasonably expected to cause the failure of the life support device or system, or to affect its safety or effectiveness.

 <p>National Semiconductor Corporation Americas Tel: 1-800-272-9959 Fax: 1-800-737-7018 Email: support@nsc.com</p> <p>www.national.com</p>	<p>National Semiconductor Europe Fax: +49 (0) 1 80-530 85 86 Email: europe.support@nsc.com Deutsch Tel: +49 (0) 1 80-530 85 85 English Tel: +49 (0) 1 80-532 78 32 Français Tel: +49 (0) 1 80-532 93 58 Italiano Tel: +49 (0) 1 80-534 16 80</p>	<p>National Semiconductor Asia Pacific Customer Response Group Tel: 65-2544466 Fax: 65-2504466 Email: sea.support@nsc.com</p>	<p>National Semiconductor Japan Ltd. Tel: 81-3-5639-7560 Fax: 81-3-5639-7507</p>
----------------------------------------------------------------------------------------------------------------------------------------------------------------------------------------------------------------------------------------------------------	---------------------------------------------------------------------------------------------------------------------------------------------------------------------------------------------------------------------------------------------------------------------------------------	-----------------------------------------------------------------------------------------------------------------------------------------------------	---------------------------------------------------------------------------------------------------

National does not assume any responsibility for use of any circuitry described, no circuit patent licenses are implied and National reserves the right at any time without notice to change said circuitry and specifications.